

Opening
new doors

Unlocking potential in the Middle East, North Africa and Turkey*

* MENAT

Contents

A Vital Force	1	Social Entrepreneurship	4
At a glance	1.1	Community Jameel	4.1
Business portfolio	1.2	Job creation	4.2
Leading the way	1.3	Global poverty alleviation	4.3
One man's vision	1.4	Food and water security	4.4
To a modern powerhouse	1.5	Arts and culture	4.5
History and milestones	1.6	Health and social	4.6
		Education and training	4.7
Our Reach	2	Spotlight	5
Our market place	2.1	On Opportunities	
Our MENAT know-how	2.2	A bright prospect	5.1
		Business development and expansion	5.2
Business Sectors	3	Ready for better	5.3
Transportation	3.1		
Vehicle distribution, retail and logistics	3.2		
Commercial vehicles and equipment	3.3		
Logistics	3.4		
Engineering and manufacturing	3.5		
Financial services	3.6		
Land and real estate	3.7		
Energy and environmental services	3.8		
About Fotowatio			
Renewable Ventures	3.9		
Consumer products	3.10		
Advertising and media	3.11		

The term 'Abdul Latif Jameel' refers broadly to several distinct, separate and independent legal entities. Abdul Latif Jameel is not itself a corporate entity, association or conglomerate run by an overarching parent company but merely refers to a group of distinct and wholly separate legal entities that are collectively referred to as Abdul Latif Jameel. Abdul Latif Jameel is not a corporate group as defined in section 1161(S) of the UK Companies Act 2006.

“If a wind blows, ride it!”

Arabian proverb

The Arabian proverb, “If a wind blows, ride it!” was a favorite of my father – the founder of Abdul Latif Jameel. It sums up his pioneering, entrepreneurial spirit that lives on in our businesses today.

Since 1945, our passion for riding the winds has already taken us into 31 countries on five continents: seeking out new markets, opening up job opportunities, developing new partnerships, finding new ways of creating value. We do all this with a clear purpose: to help people advance their quality of life by unlocking new potential.

We want to share our knowledge and experience in order to further develop business and trade within, and into, the MENAT region. It is our sincere desire to shine a light on the opportunities we know exist.

As a trusted guide, we can open doors to these exciting and ambitious markets. Together, we can be partners in prosperity.

I invite you to find out more about Abdul Latif Jameel on the following pages. I hope you find it informative.

Thank you for your attention.

Mohammed Abdul Latif Jameel, KBE
Chairman and Chief Executive Officer



A Vital Force

“One of the world’s
most engaged
and productive
organizations”

Gallup

Abdul Latif Jameel at a glance

Abdul Latif Jameel was founded on automotive operations and they remain at the heart of our business today. We have also moved into areas that enhance our automotive offer and value chain, as well as diversifying into new sectors, such as real estate and energy, where we see great potential for our company and our region.

 16,500
employees

 Zero
net borrowings

 31
countries

Fast facts

Deep knowledge and on-the-ground experience across the MENAT region

Nurturing enterprise and unlocking potential for more than 70 years

Operations in 31 countries on five continents

One of the world's leading independent Toyota distributors

One of the world's leading solar photovoltaic developers

Balanced business portfolio and strong brand partnerships

Zero net borrowings

Over 16,500 employees globally

Over 590,000 people helped into work through our job creation programs

A commitment to social and economic sustainability

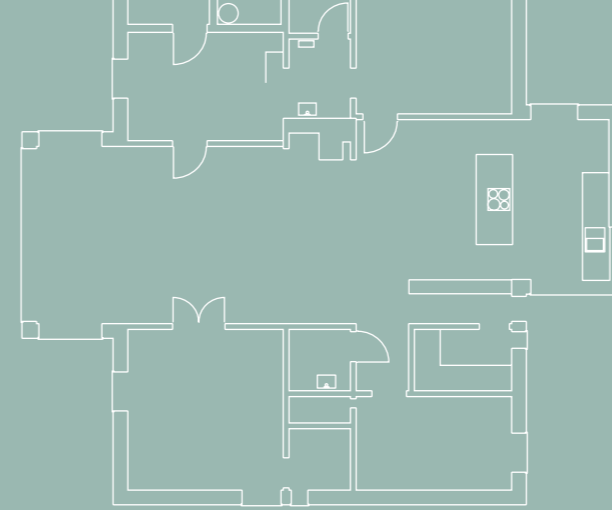
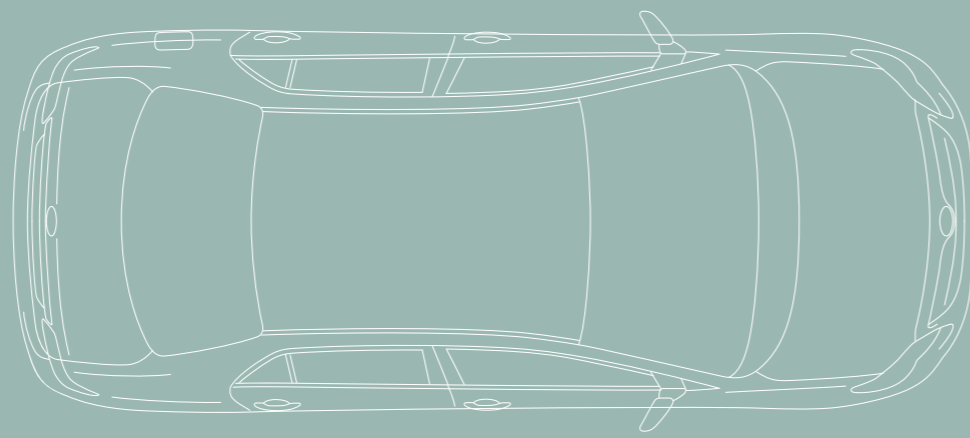

Our business portfolio

The MENAT region is our area of expertise, our origin, where we have deep knowledge of local tier 2 and 3 areas as well as capital cities – we are local to locals. From this strong base, we are growing and diversifying across the region and in sectors that contribute to the infrastructure of life.

- Expansion across the Middle East and North Africa since 1945
- Into Asian markets from 1996
- Into Turkey from 1998
- A strategic presence in Europe since 2003
- A move into sub-Saharan Africa from 2012
- Broadened into Central and South America in 2014

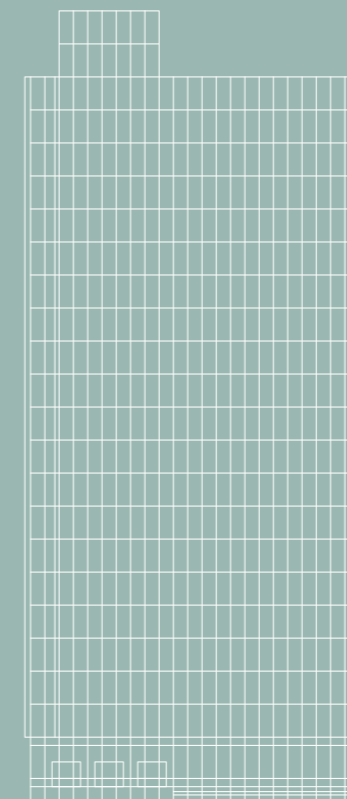
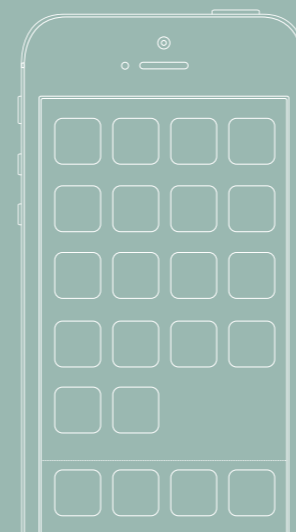
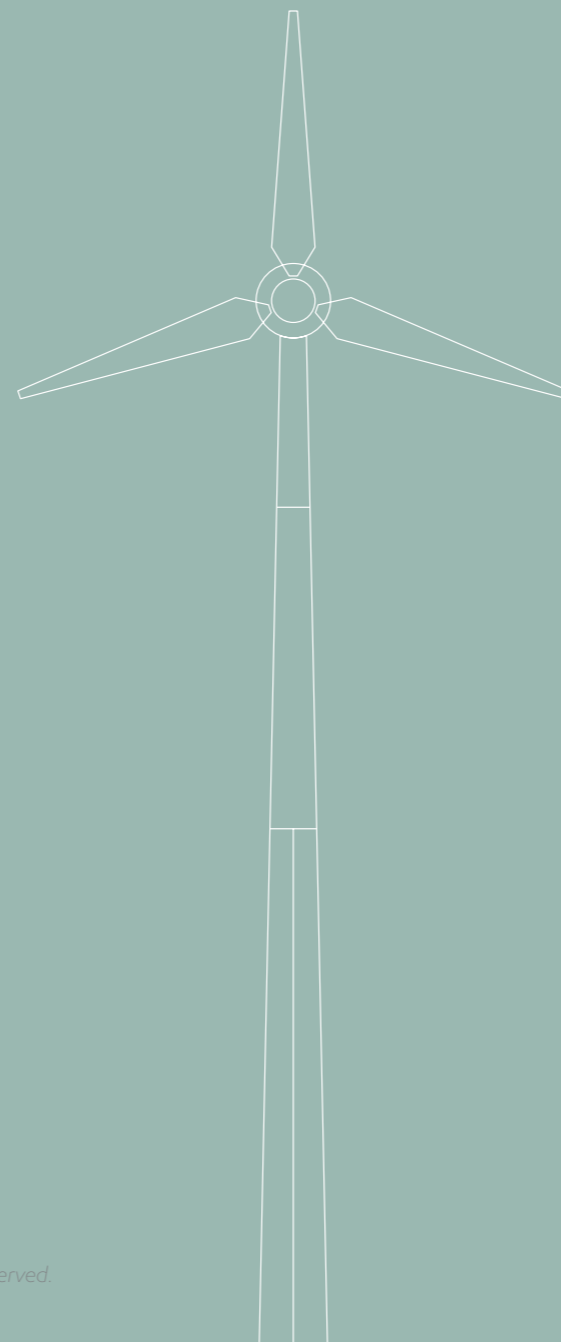

Transportation

Offering passenger car, commercial vehicle and equipment distribution and ownership solutions

Engineering and Manufacturing

Bringing accredited vehicle parts to market and supporting an integrated automotive value chain.

Financial Services

Enabling individuals and businesses to flourish

Land and Real Estate

Providing contemporary homes and planning future communities

Energy and Environmental Services

Developing renewable energy projects, energy efficiency initiatives and sustainable environmental programs

Consumer Products

Supplying quality brands and services to the region's people

Advertising and Media

Communicating with consumers and society

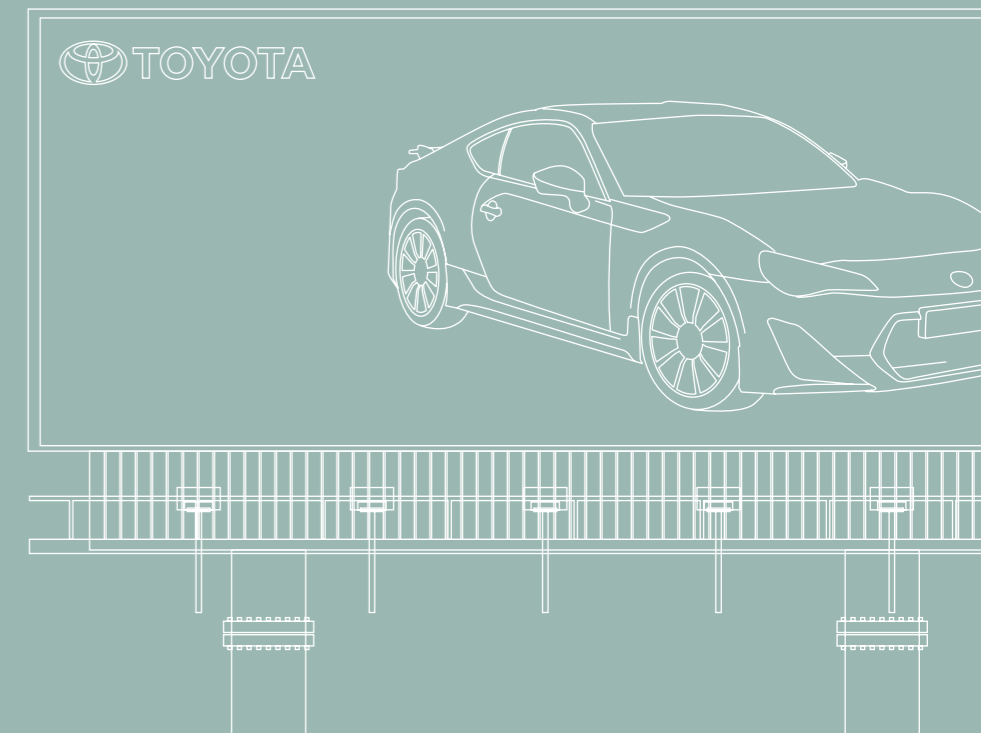

We help people who strive
for better, to have better.

We help businesses who
look further, to reach further.

Leading the way

Since 1945, from the heart of Arabia, throughout the fast-developing MENAT region and across five continents, Abdul Latif Jameel has been uncovering new potential. Our pioneering spirit, determined focus and ability to empower are reflected in everything we do.

From one man's vision...



*The vehicle that started it all:
the 1950s Toyota BJ model*



Abdul Latif Jameel is built on the vision of our entrepreneurial founder, Mr. Abdul Latif Jameel.

Some 70 years ago, he saw that increased competition within Saudi Arabia's automotive sector, as well as better personal transport, could empower businesses and individuals, in turn advancing the development of his nation. Mr. Jameel approached Japan's Toyota Motor Corporation, initially ordering just four of the company's early all-terrain vehicles. The increasing popularity of these early models led to our company being appointed as the distributor in Saudi Arabia by Toyota in 1955, a role we are still honored and privileged to hold today.

Since that time, in partnership with Toyota, we have expanded our automotive operations across the Middle East, North Africa and Turkey and into important new territories and markets in Asia and Europe.

Alongside the cornerstone of our special relationship with Toyota, we have grown and diversified thoughtfully: leveraging new opportunities and developing valued strategic partnerships in new sectors – all focused on improving quality of life.

...to a modern powerhouse...

Today, Abdul Latif Jameel is an international business and a committed social entrepreneur, with respected management and a robust corporate governance structure.

In the spirit of our founder, we continue to seek out and explore new opportunities that unlock value and advance growth in our communities.

We harness our regional know-how to identify investment possibilities and, through the smart application of technology and expertise, we transform these into profitable and progressive businesses.

...in search of tomorrow's potential

We constantly strive to open new doors, push boundaries and create fruitful connections that will bring opportunity to new and existing partners while improving the lives and prospects of millions.



*Art installation by Mounir Fatmi, Jameel Prize finalist.
With the courtesy of Nadour Collection*

History and milestones

Over seven decades, Abdul Latif Jameel has grown from a single dealership in a converted gas station in Jeddah, Saudi Arabia, to become one of the world's leading independent Toyota distributors and a globally-respected business with a successful and diverse portfolio.

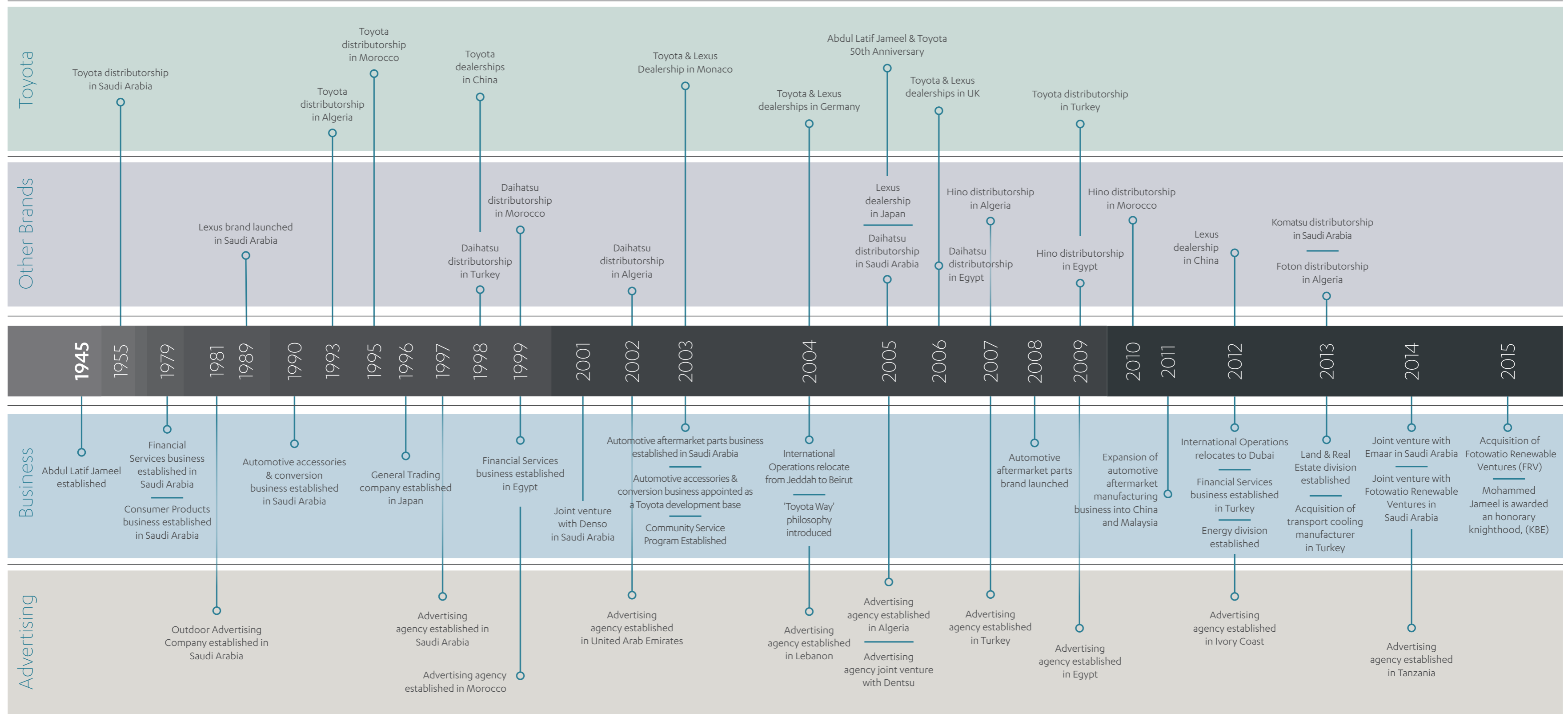



Our Reach

“At the heart of
the world’s most
exciting markets.”

Rif Abou Richeh, Vice President, Abdul Latif Jameel International

Our marketplace

In recent decades we have been exploring new markets and expanding our international reach into territories that we know offer great potential.

These highly-successful regional operations are built on our deep understanding of, and respect for, local cultures and communities.

We represent some of the world's leading brands, who trust us to deliver outstanding customer service at every touch point.

Every part of our business maintains the high quality standards these brands expect; we are passionate about the details that make a difference. The Japanese 'Kaizen' approach of continuous improvement is embedded across our company. And, collectively, our operations share one objective: a determined focus on the pursuit of better.



Our MENAT know-how

“Our best days are ahead”

ASDAA Burson-Marsteller Arab Youth Survey 2013

دوري
عبد اللطيف جميل



دوري
عبد اللطيف جميل

“MENA cities are diverse,
with disparate populations
but considerable wealth.”

The Economist Intelligence Unit

A winning partnership

Abdul Latif Jameel is the title sponsor of the Saudi Football League, the most popular league in the Arab world.

We are experts in this growing and vibrant region, and can share deep insights into its consumers and their aspirations.



88%
of the Middle East's online population
use social networking sites every day



81%
of young Arabs use the
internet every day



72%
of MENAT's smartphone owners
are younger than 34



47%
of the MENAT population
is under the age of 25

Source: World Bank 2015

Smartphone usage
2014 (millions)

2,565m
Asia-Pacific



596m
Middle-East & Africa



430m
Latin America



346m
Western Europe



341m
Central & Eastern Europe



275m
North America



Source: www.emarketer.com

Our MENAT know-how

With young, ambitious and connected populations, MENAT countries are modernizing and developing at a fast pace. Across the region, new doors are opening and new markets are thriving.



Vibrant Levent financial district, as seen from the Sapphire skyscraper – the tallest building in Istanbul

Our MENAT know-how

We see a wealth of opportunities within the MENAT region. Its citizens share a desire for advancement and, while some nations face challenges, they all welcome partners to help them progress.

Algeria

GDP	
US\$210 billion	
Population	Under 25
39.2m	46%

Algeria is Africa's fourth largest crude oil producer and the world's sixth largest gas producer. It is also diversifying into renewable energies. Strong export revenues create relative macroeconomic stability.

Iraq

GDP	
US\$229 billion	
Population	Under 25
33.4m	56%

With an educated and talented workforce, Iraq offers multiple investment opportunities that would benefit in a liberal atmosphere. Growth in the private sector and job creation are current priorities.

Bahrain

GDP	
US\$3 billion	
Population	Under 25
1.3m	36%

One of MENAT's leading financial hubs, Bahrain has a fast-growing economy, skilled workforce and liberal business environment, offering 100% foreign ownership of business assets and real estate across most sectors.

Jordan

GDP	
US\$33 billion	
Population	Under 25
6.5m	56%

Politically stable, and with a skilled workforce, Jordan is well positioned as a Middle East transportation hub, and offers strong incentives for investment and access to major international markets.

Egypt

GDP	
US\$272 billion	
Population	Under 25
82m	36%

Egypt has the largest population and one of the largest economies in the MENAT region. Its stock exchange has more than 600 companies listed and, despite recent political change, the country is investing in infrastructure projects and inviting foreign investment.

Kuwait

GDP	
US\$175 billion	
Population	Under 25
3.4m	41%

Kuwait's strong and stable economy has a relatively liberal trade policy, with open markets for foreign trade and foreign direct investment incentives. Its large oil reserves help deliver one of the world's highest GDPs per capita.

Lebanon

GDP	
US\$44 billion	
Population	Under 25
4.5m	42%

Lebanon has a multi-skilled workforce, ranking 10th globally in the quality of education. It also has one of the most liberal foreign investment climates in the Middle East with the lowest corporate rates in the world.

Libya

GDP	
US\$74 billion	
Population	Under 25
6.2m	45%

Libya's economy has been recovering since 2012. Investment opportunities abound as the country sees a surge in public spending and its oil and gas sectors resume operations.

Qatar

GDP	
US\$203 billion	
Population	Under 25
2.2m	26%

With the world's third largest gas reserves and huge petroleum resources, Qatar is currently the richest country in the world on a GDP per capita basis. It is attracting foreign direct investment to diversify its economy through new business regulations, tax exemptions, and world-class ICT facilities.

Morocco

GDP	
US\$103 billion	
Population	Under 25
33m	44%

One of the most stable countries in the MENAT region, Morocco is well placed as a link to the Americas and Europe. With a strong economy and an attractive business environment, it offers a number of investment opportunities.

Saudi Arabia

GDP	
US\$748 billion	
Population	Under 25
28.8m	47%

Saudi Arabia combines abundant natural resources with global recognition for ease of doing business. Saudi Arabia has been rated as the world's third most favorable tax environment, and has the highest level of foreign direct investment in the MENAT region. It is ideally located for global trade and logistics, with a booming consumer market and ideal fiscal conditions.

Oman

GDP	
US\$79 billion	
Population	Under 25
3.6m	50%

Oil-rich Oman is developing its non-oil industries for investment, including education, health and ICT. Oman's investment laws now allow 70-100% foreign participation in companies and various tax exemptions.

Tunisia

GDP	
US\$47 billion	
Population	Under 25
10.9m	39%

Tunisia has a strong knowledge-based economy, with a highly-skilled workforce. Its proximity to Europe has resulted in strong trade agreements with both the EU and MENAT region, and a growing, stable infrastructure.

Turkey

GDP	
US\$882 billion	
Population	Under 25
74.9m	42%

With access to 1.5 billion customers, Turkey is the world's 16th largest economy and one of the most dynamic economies in the MENAT region. Its increasing population, qualified and competitive labour force and liberal investment policies, make it ideal for foreign direct investment.

UAE

GDP	
US\$402 billion	
Population	Under 25
9.3m	34%

The UAE has extensive natural resources and strong financial sectors, contributing to a large annual GDP. It is considered one of the best destinations for foreign direct investment, as it maintains an emphasis on free trade, with a free transfer of profits, revenues and assets, and low customs tariffs.

Yemen

GDP	
US\$36 billion	
Population	Under 25
24.4m	63%

Yemen has one of the world's highest population growth rates and it is rapidly developing its infrastructure to accommodate this, thus creating a number of investment opportunities.



Business Sectors

“Growing with
foresight, insight
and logic.”

Fady Jameel, Deputy President & Vice-Chairman, Abdul Latif Jameel-International

Transportation

From our first order of four Toyota vehicles in 1955, we have created a worldwide transportation business.

Today, we are one of the world's leading independent Toyota distributors – having been their proud partner for over 60 years – offering full brand representation including wholesaling, marketing, sales, servicing and accessorizing of vehicles and their spare parts in key markets across MENAT, and in Asia and Europe. Today, our passenger vehicle portfolio also includes the world renowned brands Lexus, Daihatsu and Ford.

Recognizing the infrastructural development needs of the region, we have expanded to bring commercial vehicle and equipment brands including Hino, Foton, Komatsu, Toyota Industrial Equipment, Foton-Loxa and Manitou Group to various markets.

In our home country of Saudi Arabia, Abdul Latif Jameel has one of the largest automotive sales and aftersales networks, with over 400 outlets, as well as successful accessory manufacturing and assembly operations. Our MENAT automotive operations extend further across Morocco, Algeria, Egypt, and Turkey.

In 1996, seeing new potential in Asia-Pacific markets, we established automotive operations in China, Japan, Malaysia and Singapore. In 2003 we set up a small strategic presence in the key European countries of Germany, the United Kingdom and the principality of Monaco.

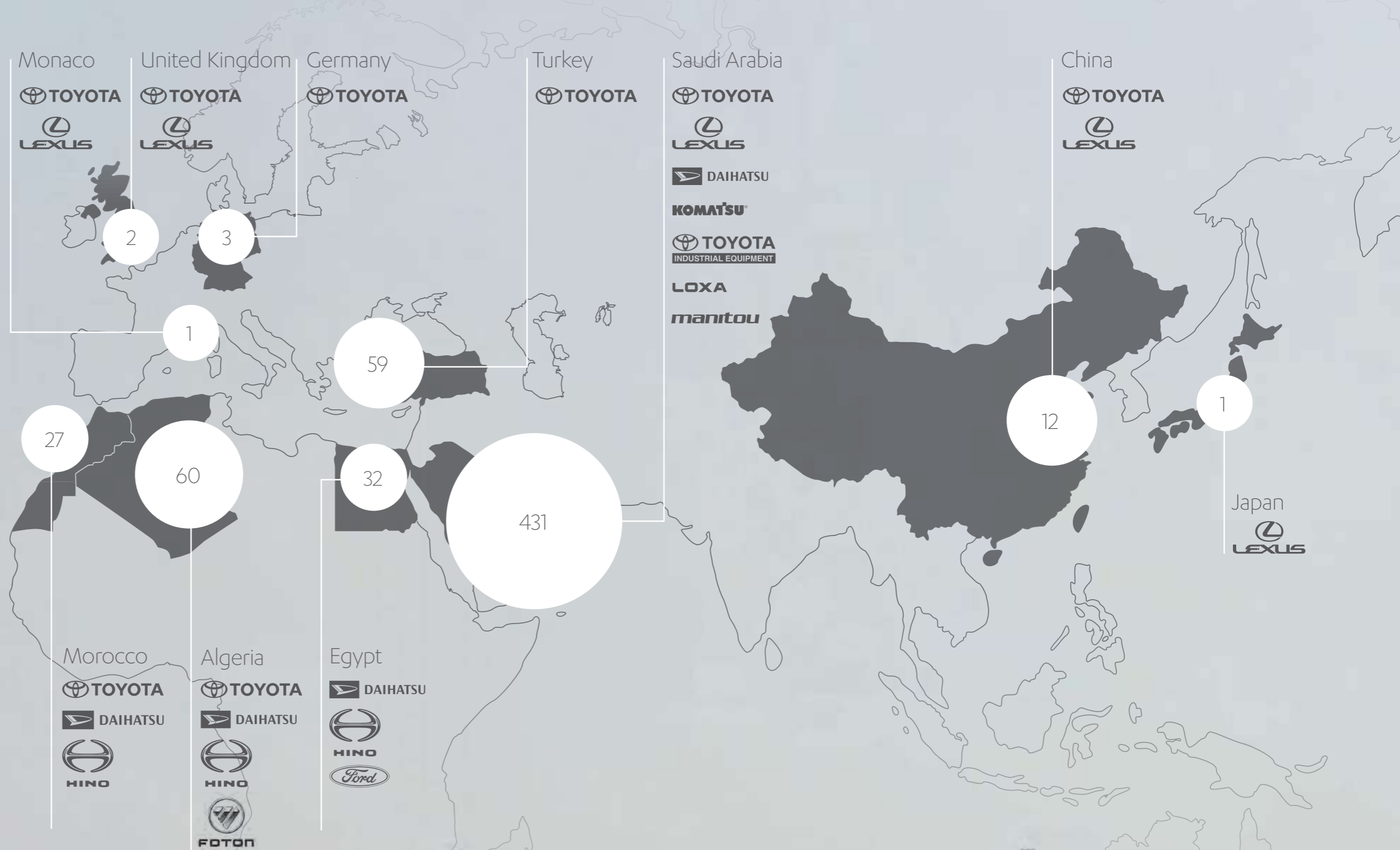

Total Network



30,000 vehicles are in transit every week at the Abdul Latif Jameel vehicle stockyard, Khumra – near Jeddah

Transportation

Vehicle distribution, retail and logistics

Our 'Guest First' philosophy is at the heart of everything we do and has served us well since 1955.

From 2008 to date we have sold over 2.4 million new vehicles and in 2014 we achieved record new vehicle sales across the Abdul Latif Jameel global network of 442,000 units.

In today's highly competitive new vehicle market we understand the value of winning, delighting and retaining a hard-won customer for life. From 2008 onwards we have deployed our own customer engagement and satisfaction process.

The Abdul Latif Jameel 'Guest First' approach strives to achieve a world-class level of customer satisfaction and we deploy it across our entire automotive retail network to achieve a consistent level of customer experience.

We have received numerous awards and accolades for our customer service but, in keeping with the 'Kaizen' philosophy, we are never satisfied. We continuously aim for better.



400+ branches in Saudi Arabia



335,000 vehicles currently under lease in Saudi Arabia



12,000+ employees working in the automotive sector

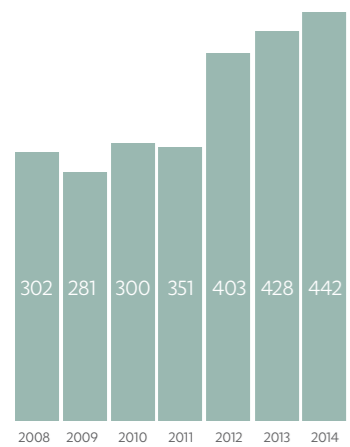

New vehicles sold (000 units)
*Rounded figures

“The vast service network and favorable financing deals offered by Abdul Latif Jameel...helps to explain [Toyota’s] continued market lead.”

The Economist Intelligence Unit

Fast facts

442,000 new vehicles sales in 2014 – a record year

Total network of 630+ branches across MENAT, Europe and Asia Pacific

One of the leading auto finance companies in the Middle East

139,000 hours of automotive aftersales staff training in 2014



Abdul Latif Jameel Toyota Plaza dealership in Çekmeköy, Istanbul

Transportation

Vehicle distribution, retail and logistics

To support our successful transportation sector businesses, Abdul Latif Jameel has developed one of the MENAT region's largest automotive supply infrastructures.

Our central warehousing and port processing facilities in Saudi Arabia have the capacity to receive and dispatch 1,200 vehicles per day with stocking capacity for 69,000 vehicles. We will double this capacity when our new processing and logistics center north of Jeddah opens in late 2015.

Our spare parts logistics business in Saudi Arabia serves our domestic automotive business.

We handle over 700 sea container shipments a month with 20,000 order lines shipped per day via a 'just-in-time' spare parts picking process controlled by the latest barcode scanning and pick by voice technology.

Fast facts

In-bound vehicle deliveries from 12 ports of origin worldwide

Total vehicle storage area in excess of 1,700,000m²

43 million spare parts received into Saudi Arabia parts warehouses in 2014

85,000m² of spare parts warehousing storage

1 million kilometres a month traveled by our road freight delivery fleet in Saudi Arabia



*Abdul Latif Jameel vehicle stockyard,
Khumra – near Jeddah*

Transportation

Commercial vehicles and equipment

Our diversification into the commercial vehicle and equipment sector is aligned to Abdul Latif Jameel's commitment to advancing the development of Saudi Arabia and the MENAT region.

By providing world-class construction equipment, commercial vehicles and specialist training and servicing, as well as Sharia-compliant financing, we are contributing to the continuous development of the region's infrastructure.

Our 'Abdul Latif Jameel Machinery' division represents brands such as Hino and Foton trucks and has been the authorized distributor for Toyota Industrial Equipment and spare parts in Saudi Arabia for the past 26 years including petrol, diesel and electric forklift trucks and towing tractors.

In 2013, we began to represent the leading Japanese brand Komatsu in Saudi Arabia, forming Abdul Latif Jameel Heavy Equipment. This offers an extensive product line-up including wheel loaders, excavators, bulldozers, dump trucks, articulated trucks and pipe layers.

Continued expansion in 2015 saw the addition of Manitou Group tele-handlers and Foton-Loxa cement equipment further broadening our ability to serve the growing construction sector.

Customer care is central to our business. We strive to become our customers' preferred partners, supporting them for the life of

the equipment. This includes initial consultancy advice on the type of product they should buy, proposing financing solutions, service agreements, onsite repairs and operator training, technical training, immediate availability of most parts, comprehensive onsite service and equipment rental options to ensure operating continuity.

We have adopted the Kaizen style concept of continuous improvement across all parts of our commercial equipment business, with a focus on delivering the best experience to our customers – from the quality of products and operator support, to the efficiency and skills of our technicians and service engineers.

 100%
All mainstream parts available immediately

 24/7
On-site repairs and servicing

Brand new Komatsu excavators, Jeddah

Transportation

Logistics

In 2015, Abdul Latif Jameel moved into non-automotive logistics for the first time when the business was named as the new Global Service Provider for FedEx Express in Saudi Arabia.

With over 60 years of proven logistics experience in the region, a keen focus on customer care and service delivery, we have both the experience and the expertise to make this a clear choice for FedEx Express and to become the premier transportation provider in the country.

Demand in Saudi Arabia's transport and logistics sector is expected to increase significantly in the future with industry experts predicting 5% annual growth for international cargo, and up to 8% for air and

sea cargo until 2020. Abdul Latif Jameel will allow FedEx Express to utilize its deep market expertise to meet the country's growing shipping needs.

The business is already operating with new and state-of-the-art infrastructure, including facilities, a fleet of vehicles and an experienced team.

“More than US\$ 100 bn. of investment is anticipated within Saudi Arabia's transportation and logistics sector over the next 10 years.”

Saudi Arabian General Investment Authority (SAGIA)



FedEx Express, the world-renowned transport and logistics company, has been active in Saudi Arabia for more than 20 years.

Engineering and Manufacturing

As our operations grow, so has our strategy of providing a comprehensive range of products and services throughout the automotive life cycle.

Abdul Latif Jameel is actively involved in the manufacturing, assembly and distribution of automotive components, accessories and aftermarket parts. We are also, through direct investment or partnerships, expanding into a growing number of automotive related aftermarket consumer offerings.

Manufacturing and Assembly Facilities, and Accessories Network



Manufacturing and Assembly

In 2001, Abdul Latif Jameel formed a joint venture with DENSO, one of Toyota's key partners, and today provides air conditioning and refrigeration equipment needed to transport people comfortably and safely transport perishable goods.

This enterprise is based in Saudi Arabia, and manufactures and assembles air conditioning for the Toyota Hilux pick up, and is supported by over 20 service centers in Saudi Arabia. The joint venture also remanufactures DENSO products including air conditioning compressors and diesel supply pumps, and additionally includes the distribution of DENSO parts across North Africa. In 2014, we further extended our relationship, with DENSO adding air conditioning manufacturing to Abdul Latif Jameel's operation in Turkey. Our Turkish operation provides air conditioning and refrigeration equipment to a broad section of the local transport industry.

Engineering

Abdul Latif Jameel owns and operates three successful automotive aftermarket parts brands, DJ Parts, P2 and FBK. All products in the DJ Parts range are researched and developed at our Singapore hub. Out of its factories in Malaysia and China, FBK transforms raw materials into brake friction products. Distribution of these products takes place through an international network of appointed dealers, and also through our own distribution points in Turkey, Saudi Arabia, Algeria, Egypt, China and Malaysia.

Accessories and Personalization

Abdul Latif Jameel Accessories and Conversion Services has grown steadily from its initial vehicle air conditioning and audio operations in the 1990s and now offers localized equipment integration and vehicle accessorization across the region.

In 2003 Abdul Latif Jameel was proud to be named as an official Development Base for Toyota accessories. This status enables us to work in close partnership with Toyota, drawing on technical assistance to develop Toyota-approved equipment and accessories for Toyota vehicles. A similar Development Base status was obtained from the Daihatsu Motor Corporation in 2007.

Today, we operate an extensive equipment installation facility in Jeddah, Saudi Arabia where the Toyota Production System is fully implemented in the integration of Toyota and Daihatsu approved equipment and accessories into a number of their respective products imported into the region.

In 2015, we launched a pioneering retail accessorization and vehicle personalization service in Saudi Arabia under our 'Gear Up' brand, catering to the increasing consumer demand for such services. We employ talented engineers and designers, keep track of the latest research innovations and develop Toyota-approved products sourced from 67 suppliers in 18 countries across five continents.

Key events

1990 – Established Accessories & Conversion Services

2001 – Joint venture with DENSO on air conditioning services

2003 – Aftermarket parts business established in Saudi Arabia; Appointed authorized development base for Toyota

2008 – DJ Auto aftermarket parts brand launched

2010 – Acquisition of the FBK brand

2011 – Expansion of automotive aftermarket manufacturing into China & Malaysia

2013 – Acquisition of transport cooling manufacturing company in Turkey

2015 – Launched Gear Up vehicle personalization service



FBK brake pads, fresh out of the Curing Oven

Financial Services

Combining Islamic heritage and pioneering design in the development of the Techno Valley, Riyadh



<1%
default rate for collections



608,000
vehicles financed since 2008



335,000
vehicles currently under lease in Saudi Arabia

Back in 1979, we saw the potential for enabling people and businesses to flourish through instalment plans for vehicle purchases.

Our foresight has now positioned Abdul Latif Jameel Leasing as the number one auto finance company in the Middle East.

We have also pioneered Islamic financial solutions, including the Musharakah model, which plays such a vital role in financing business operations in Saudi Arabia and other Muslim nations, where finance must comply with Sharia laws. These innovative solutions offer mutually beneficial and risk-managed terms, providing finance to borrowers to whom banks do not lend, which improves customers' lives and results in exceptionally low default rates.

Across Saudi Arabia and through its finance arms in Turkey and Egypt, Abdul Latif Jameel Leasing employs over 3,200 associates in more than 280 branches are all focused on helping to fulfil our customers' hopes and aspirations.

In addition to auto finance, our financial services span leasing, and financing for home appliances, heavy equipment and real estate. Our customers benefit from transparent, reliable Sharia-compliant real estate financing services for homes.

Land and Real Estate

According to the world's leading real estate investment and advisory firm, Jones Lang LaSalle, the MENA region is facing a shortage of 3.5 million homes, with demand outstripping supply for at least the next five years.

We anticipated the needs of Saudi Arabia's rising population and growing urbanization by establishing Abdul Latif Jameel's real estate company in 2012.

We are already one of Saudi Arabia's leading land and property developers, working to deliver pleasing environments for individuals and businesses alike.

Abdul Latif Jameel is addressing the demand for contemporary and affordable homes in Saudi Arabia through innovative methods that produce superior quality pre-cast homes in one-third of the time required for a standard build.

We are also developing conventional homes, including a compound of 200 new homes in Jeddah. The project has been created with both visual comfort and sustainability in mind, with discreet parking, shaded landscaping and planting and solar harvesting.

Our real estate operations are now expanding into other markets in the MENAT region as well as investments in land holdings across the wider world and through partnerships with like-minded investors and developers.

In 2014 we partnered with Emaar Properties, the global developer of iconic real estate assets to develop integrated property projects in Saudi Arabia. The two companies will launch the projects under the partnership entity, Emaar Jameel.



3.5m
Demand for affordable housing in MENA to 2019



2x
MENA Population growth is 2x world's average

“The provision of sufficient levels of affordable housing represents probably the single greatest opportunity for the real estate industry in MENA at the present time.”

Deepak Jain, Jones Lang LaSalle, Why Affordable Housing Matters

Energy and Environmental Services

With power demand in the MENAT region set to grow by 7% annually until 2020*, the development of additional renewable energy sources is a social and strategic imperative.

New energy targets established by the Gulf Cooperation Council countries and those of the wider MENAT region are opening up significant opportunities in power production and conservation.

Focusing on environmental and social responsibility, as well as regional government initiatives, we're prioritizing energy efficiency and reduced consumption of finite resources. We're positioned to meet these needs and bring sustainable power to the region by partnering with energy experts and tapping the financial acumen and operational strength of the wider Abdul Latif Jameel organization.

Together with our energy partners, we will lead the region in creating sustainable energy through power infrastructure development, sustainable power generation, alternative resources, and energy efficiency.

Harnessing natural resources

Our initial focus is in photovoltaic (PV) solar energy which is why, in 2015, we acquired Fotowatio Renewable Ventures (FRV), a leading international developer of large-scale solar projects. While we bring regional knowledge and financial capability to the table, FRV brings its extensive experience in engineering, development and construction of solar, and wind, installations.

Our combined strength makes us the largest GCC-based solar photovoltaic developer and one of the largest in the world. We are continuing to explore investment and expansion opportunities into Engineering, Procurement and Construction (EPC), operation and maintenance.

Abdul Latif Jameel Energy is also assessing development potential in Concentrated Solar Power (CSP), waste-to-energy, wind, waste management, and desalination.

In line with our ongoing commitment to economic development, we place a key focus on building a sustainable legacy in countries where we establish projects. We aim to create jobs at all levels, including the training of the local workforces to create renewable energy expertise within these countries.



Renewable energy as art – Giant Solar Panel, The Forum, Barcelona, Spain

* Economist Intelligence Unit (EIU),
“The GCC in 2020: Resources for the future”

About Fotowatio Renewable Ventures

Fotowatio Renewable Ventures (FRV) is one of the leading global operators in photovoltaic (PV) and thermo-solar energy, specializing in the complete management of solar assets for the generation of electricity using the sun as the source.

Since the company was founded in the Netherlands in 2006, it has built a solid track record of developing world-class operational solar PV assets across the globe – in the USA, Europe, Latin America, Africa and Australia. Its activities are focused on the development, construction, financing, operation and maintenance of a wide portfolio of solar plants, all of which are both technologically and geographically diversified.

To date, FRV has participated in the development of over 3.1 GW across 15 countries in five continents.

Today, the Company has operations in 20 countries across the globe and has a total energy pipeline of 4.3 GW. Having enjoyed significant success in various markets, FRV has recently set its sights on opportunities in the Middle East and North Africa (MENA) region with Abdul Latif Jameel to open new doors here.

With FRV's extensive experience in the solar PV sector and Abdul Latif Jameel's deep local knowledge, this acquisition builds upon Abdul Latif Jameel's desire for a better world for today, and for tomorrow's generations.



FRV has successfully developed more than 532 MWdc in photovoltaic solar power across five continents.





Consumer Products

Following our introduction into electronics and air conditioning in the 1950s, Abdul Latif Jameel Electronics is today one of Saudi Arabia's leading distributors of electronics, consumer durables, air-conditioning and audio-visual solutions and home appliances to consumers and corporate customers.

We distribute, retail and also provide comprehensive after-sales support for products that enhance peoples' lives at home, at work and on the move: from air conditioners and water dispensers to TVs, laptops, smartphones and tablets.

We are proud to represent many of the world's prestigious brands, including Toshiba, Sharp, White Westinghouse, Alpine, Rheem, Mekar and DORA, and have built a strong reputation among these brand partners for outstanding sales, customer service and innovation.

We reach Saudi Arabia's 30 million consumers through 16 showrooms, more than 14 service centers and a network of over 500 dealers. We are increasingly investing in e-commerce operations and broadening our product offering in IT, AV and broadcasting, and security systems.

Through these expanding retail channels and product lines, and with the benefit of our progressive finance and incentive plans, we are playing an important part in improving the quality of our customers' day-to-day lives.



Abdul Latif Jameel state-of-the-art consumer electronics retail environment, Khaleidiya, Jeddah

Products and Services

Mobile



Smartphones



Tablets



Notebooks

Electronics



Refrigeration



Television



Air-conditioning



Laundry

Corporate Solutions



Tailored Air-conditioning solutions



Tailored Audio-visual solutions

Advertising and Media

More than 30 years ago, recognizing the importance of communicating with consumers and society, Abdul Latif Jameel set national precedents by promoting its automotive products on outdoor billboards. Soon, we developed an extensive network of boards across Saudi Arabia.

From this pioneering initiative, we now offer a full range of advertising, media, and public relations across the MENAT region, enabling us to promote our businesses, create jobs and foster growth. National and international brands continue to increase their marketing expenditure in the region, with average MENAT advertising spend forecast to grow by 7% over the next two years.*

All Abdul Latif Jameel companies – and many valued clients – tap into our marketing expertise to help build brands and to reach the consumers that matter.

**ZenithOptimedia forecasts*



Drive Dentsu's Dubai offices

Drive Dentsu

This full-service advertising agency was established in 1997 to initially service Abdul Latif Jameel's needs in Saudi Arabia and has grown as the group has expanded internationally. It now provides brand consultancy, strategic planning, creative, design and digital services to many clients in the automotive, telecommunications, financial, real estate, retail and customer product sectors.

Its 300+ people serve MENAT and international clients from 9 offices in seven countries and offer deep local insights and cultural understanding.

The agency has access to a global network of approximately 37,000 people following a joint venture in 2005 with Dentsu, the Japan-based global marketing services company.

Abdul Latif Jameel Outdoor Advertising Company

A pioneering force in Saudi Arabia advertising, the company was established in 1981 to project strong brand messages in many categories to the country's consumers. It is now one of Saudi Arabia's leading outdoor advertising companies, with 110 advertising sites across the country's major cities and a growing vehicle livery operation.

The Company offers a turn-key service, from manufacturing, maintenance and digital printing to campaign planning and evaluation.

Delphys

In 2015 Abdul Latif Jameel and Delphys, the Toyota in-house creative advertising agency, announced the formation of a joint venture business in Dubai. The purpose of this new joint venture agency is to support and collaborate on growing the Toyota business across the MENAT region.

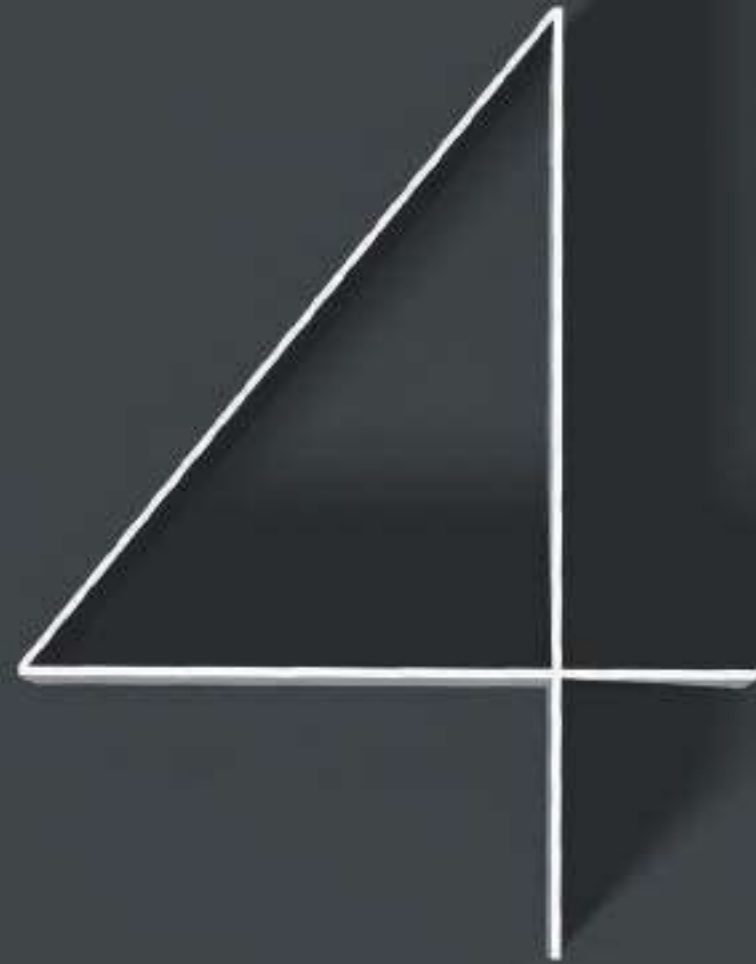

Social Entrepreneurship

“The capacity
to change
the world.”

Tony Blair, former Prime Minister of the United Kingdom

Community Jameel

Advancing human potential is a business imperative at Abdul Latif Jameel. From our earliest days, we have been pioneers for active and positive social change – in the local communities which we serve, and far beyond.

In 2003, we formalized our commitment to social and economic sustainability by creating a dedicated organization, Abdul Latif Jameel Community Initiatives, now Community Jameel, which focuses on six areas:

- Job creation
- Global poverty alleviation
- Food and water security
- Arts and culture
- Health and social
- Education and training

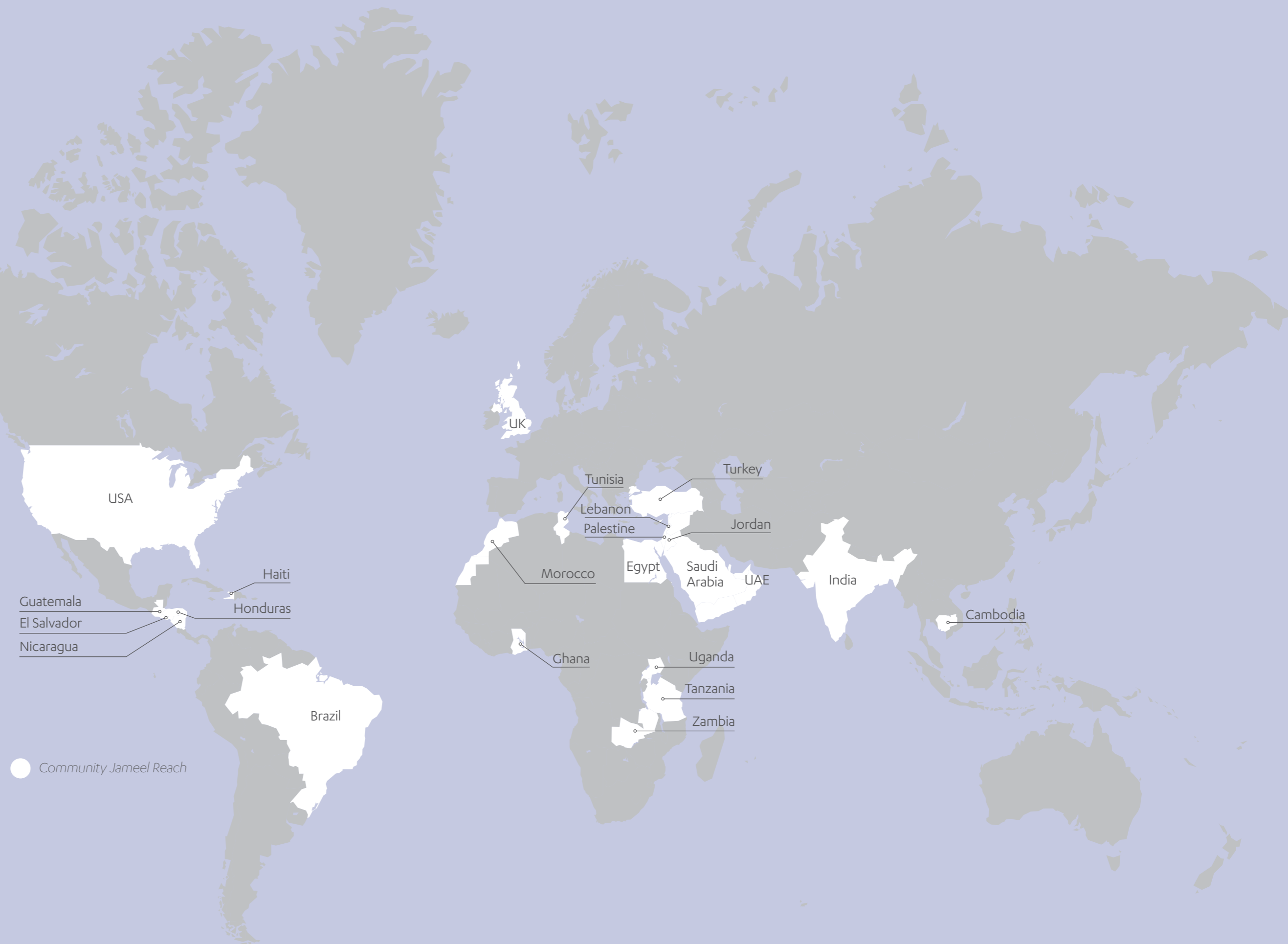

Job Creation

Since its inception in 2003, our Bab Rizq Jameel – “beautiful gateway to prosperity” – program helps promising young men and women throughout the Arab world to find brighter futures and advance mobility.

From 2003 to date, Bab Rizq Jameel has helped to create some 590,000 job opportunities globally through its operations across Saudi Arabia, Egypt, Turkey and Morocco. Unemployed people have moved into work through taxi and truck ownership programs, specialist skills training, job placements and small business opportunities.

In Saudi Arabia, Bab Rizq Jameel has helped to create 410,000 job opportunities since 2013. During 2014 alone, Bab Rizq Jameel helped to create over 75,000 job opportunities within the country – with 25,000 of these specifically for female Saudi nationals.

These achievements led to Bab Rizq Jameel being awarded the prestigious Arab Social Media Influencers Award in recognition of the organization’s success in generating job opportunities through its social media platforms.

Its innovative Working from Distance initiative, established in 2013, helped to create 7,496 job opportunities in 2014 for women to work from home in the areas of telesales and marketing, call centers and customer services.

In late 2014, Bab Rizq Jameel launched a new operation, BRJ International, which is headquartered in Dubai. BRJ International will complement the efforts of the Bab Rizq Jameel organization as well as seek to attract highly skilled and experienced professionals into the MENAT region.

Bab Rizq Jameel has ambitious targets to help to create more job openings every year, through its network of 2,000 job creators.

“I wish we had someone in the United States doing what BRJ is doing in the Middle East.”

David M. Rubenstein, co-founder and managing director, The Carlyle Group

 590,000+ jobs created globally since 2003

 410,000+ jobs created in Saudi Arabia since 2003

 75,000+ people given jobs in Saudi Arabia in 2013



Saudi national Hala Omar’s office interior design business benefited from BRJ’s Small Projects Financing Program



Global Poverty Alleviation

Lifting people and communities out of poverty is this century’s biggest challenge. We address it at both the highest levels and at the grass roots through a number of leading initiatives.

The Abdul Latif Jameel Poverty Action Lab (J-PAL) is a global network of 92 affiliated professors that use the power of scientific evidence to understand what really helps the poor. Evidence generated by J-PAL has led to the scale-up of proven programs – from more effective distribution of subsidized rice in Indonesia to school-based deworming and chlorine dispensers for safe water in Africa and India.

Through its headquarters at the Massachusetts Institute of Technology (MIT) and independent regional offices in Africa, Europe, Latin America, North America, South Asia and Southeast Asia, J-PAL partners with governments, NGOs and international development organizations to find lasting solutions to poverty. Its work has already had a direct effect on 164 million people.

In addition, D-Lab, also at MIT, is building a global network of innovators to design and disseminate technologies that meaningfully improve the lives of people living in poverty.

D-Lab Scale-Ups was created in 2011, with support from Community Jameel to identify and scale technology solutions with potential for wide scale poverty alleviation. Three years later, Scale-Ups includes a social entrepreneur fellowship program; the Harvest Fuel Initiative, a technical assistance program for East African agricultural waste charcoal producers; an active research and development arm; and an industry consortium on market-based solutions to poverty.

To date, Scale-Ups-assisted enterprises have created 248 full-time jobs in developing countries, and have indirectly employed an additional 400.

Now in its tenth year, our pioneering microfinance initiative, Grameen Jameel, has extended capital and technical support to more than 20 microfinance institutions in 10 countries across the MENAT region, helping them to expand their reach and impact on the poor, especially women. Last year, through these partnerships, more than two million people have been empowered to make their own living.

 164m people touched by the work of J-PAL

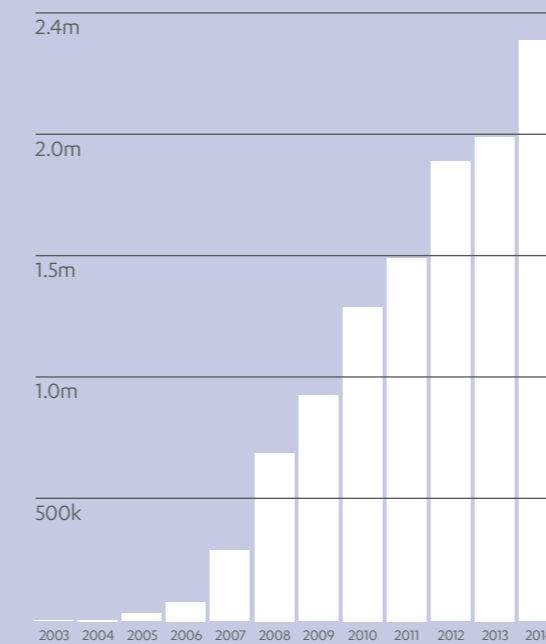

Number of clients reached by Grameen-Jameel through MFI partners since 2003

“J-PAL (the Abdul Latif Jameel Poverty Action Lab), has just celebrated its tenth anniversary. Its methods have transformed development economics.”

The Economist

Food and Water Security

Complementing the efforts of J-PAL, the Abdul Latif Jameel World Water and Food Security Lab (J-WAFS), was established at MIT in September 2014.

The lab aims to address critical issues surrounding global food and water resources in the 21st Century through scientific research, technology innovation, regional case studies, and policy recommendations.

By spearheading this research, the results can be translated into real-world outcomes for the solution of humanitarian and societal challenge, helping mankind adapt to a rapidly changing planet and combat world-wide water scarcity and food supply.

J-WAFS will also draw upon MIT's extensive research capabilities to explore the collective pressure created by population growth, urbanization, and development, as well as the impact of climate change. These are all factors that threaten the food and water systems in both developed and developing countries. The research will also help to identify appropriate policies that need to be adopted to create a positive effect on the lives of people around the world.



“Ensuring sustainable and affordable access to food and water for all is one of the most pressing challenges facing humanity.”

MIT President L. Rafael Reif

Hussein Jameel Associates House, HQ Campus, Jeddah:
Corporate meeting space meets art gallery



Arts and Culture

From the breath-taking Jameel Gallery for Islamic Art at London's Victoria & Albert Museum and its associated 'Jameel Prize', to the Jeddah Sculpture Museum featuring the work of Henry Moore, Joan Miró, Alexander Calder, Mustafa Sunbul and Rabia Al-Akhras, Abdul Latif Jameel is proud to showcase contemporary art to global audiences.

Through the Cairo satellite of the Prince's School of Traditional Arts (a venture established by HRH The Prince of Wales in London) the Art Jameel Programme for Traditional Arts at the Fostat Centre, supports the teaching of the philosophical principles and practical techniques of the traditional arts of the world's great civilizations. In June 2014, it graduated its third cohort of students and now has a body of over 50 alumni. Art Jameel has provided young artists and artisans in Egypt and further in the Arab world with the opportunity of honing their design and craft skills and eventually engaging in an art-related profession or employment.

We also foster and promote a thriving arts scene within the MENAT region by creating strong partnerships with art organizations worldwide which provide a regional platform for contemporary art. Additionally, we actively support creative businesses and are developing special art and cultural exchange programs to encourage networking and collaboration.

Our future plans include a new art center, scheduled to open in Dubai in 2017, featuring contemporary art from across the MENAT region.

“It is impossible to calculate the value of an initiative like this [Tanweer], but the expressions on the faces tell their own story.”

Mohammed Al Harbi, Ministry of Social Affairs

Health and Social

Abdul Latif Jameel is committed to improving the health and wellbeing of Saudi Arabia’s more vulnerable citizens through its health and social initiatives. We built and fund a 120-bed medical rehabilitation hospital and are a founder partner of the Prince Salman Disability Research Center.

Other targeted initiatives include social and medical care for the elderly, motivational support for orphans through the Tanweer programs, the world’s tallest flag in Jeddah and family days for prisoners to facilitate their rehabilitation on release.

The not-for-profit Abdul Latif Jameel Hospital opened in Jeddah in 1996, and has served over 45,000 patients to the end of 2013



Championing education for all ages – A child enjoys our ‘1001 Inventions’ traveling exhibition

“I am delighted to see the success of the initiative called 1001 Inventions, which presents and celebrates the many scientific, technological and humanitarian developments shared by the Islamic world and the West.”

HRH Prince Charles

 1000+
total number of scholarships

 120m
people reached through Partnership with 1001 Inventions

Education and Training

We champion education for all ages across a number of programs through Education Jameel.

In partnership with the Ministry of Education, we founded INJAZ-Saudi Arabia, which prepares young people for the real world of work.

Through the MIT Abdul Latif Jameel Toyota Endowed Scholarship, over 1,000 scholarships have been granted to MIT graduates since 1994. The programme was created to make studying at the visionary MIT institution a reality for selected scholars from Middle Eastern and Asian countries. Students are hand-picked based on their ability, dedication and potential and supported through their studies to achieve their professional goals. To date Jameel/Toyota graduates have pursued careers in architecture, economics, electrical engineering, math, chemistry, physics and aviation sciences.

For budding entrepreneurs, the MIT Enterprise Forum of the Pan Arab Region provides a platform for networking, knowledge sharing and mentorship, and Abdul Latif Jameel encourages success by organizing the annual MIT Enterprise Forum Arab Start-up Competition which targets 21 countries in the Arab region and brings in more than 5,000 applications every year.

Our award-winning traveling block-buster exhibition and educational program, 1001 Inventions, is an international science and cultural heritage brand reaching 120 million people around the world. 1001 Inventions uncovers a thousand years of scientific and cultural achievements from Muslim civilization, and how those contributions helped shape our modern world.

5

Spotlight On New Opportunities

“The MENA region and Turkey are a fertile ground for private market activity.”

Gulf Business, 15 December 2013

(referencing Talal Al Zain, chief executive officer of PineBridge Investments Middle East)

A Bright Prospect

We see great potential for inward and outward investment in the modernizing countries of the MENAT region. Conditions are very promising, with the IMF predicting healthy growth rates for many areas in the region.

As living standards improve through better infrastructures and increasing budget expenditure, vast new markets of aspirational consumers have developed, in much part due to the region's young and increasingly educated demographic.

We want to encourage their ambitions through trading and investment opportunities that will enable these new markets and their people to grow and prosper.

“I am very confident that the talent and values are in place to make this region [MENA] fit for the new realities that we have to face in the world.”

*Klaus Schwab Founder and executive chairman World Economic Forum
(Opening plenary of the World Economic Forum on the Middle East and North Africa)*

Business Development and Expansion

Across the MENAT region, new doors are opening and new markets are thriving. We're seeing growing populations of aspirational consumers, many of whom are increasingly of a more educated younger generation. With these increasingly youthful, ambitious and connected populations, MENAT countries, and their governments, are modernizing and developing at an incredible pace.

We see a wealth of commercial opportunities to leverage, and as a respected partner and trusted advisor in the MENAT region, Abdul Latif Jameel is uniquely positioned to facilitate business and trade within the region and beyond.

In 2014, Abdul Latif Jameel established the Commercial Development Company with the purpose of identifying further business development opportunities, dedicated specifically to our home market of Saudi Arabia. This investment arm will specialize in forging M&A, joint ventures, strategic alliances, and will focus on accelerating growth through business partnerships as well as greenfield investments. In addition, this Company will also oversee Abdul Latif Jameel's existing auto-adjacency businesses, such as component and accessory

fitting and manufacturing, vehicle conversions, telematics and our oil and lubricant related businesses. Multi-branded pre-owned vehicle retail, and body and paint services will also be areas of focus. As a key growth imperative, the Commercial Development Company will strive to attract potential partners, linking together opportunities from inside and outside of Saudi Arabia.

We are also expanding in markets outside of Saudi Arabia, and are in continual pursuit of new business relationships, both regionally and globally. Abdul Latif Jameel will venture into businesses and sectors where we can bring value, by facilitating relevant trade and investment opportunities, enabling our partners to prosper.



Sunrise over Abu Dhabi

Key events

2015 – Named as Global Service Provider for FedEx Express in Saudi Arabia; Acquisition of Fotowatio Renewable Ventures (FRV)

Ready For Better

The IMF recently called for improved access to finance to help catalyze entrepreneurship and private investment in the area. We are already here: on the ground, with a deep knowledge of the markets and assets ready to deploy. Our strong links with governments, financial institutions and brand partners make us uniquely placed to make the right introductions and connections.

With our long heritage of fostering and nurturing relationships throughout the communities that we serve, Abdul Latif Jameel is a respected guide, partner and trusted advisor in the MENAT region.

MENAT is rich in possibilities, with 364 million ambitious consumers eager for better. Let us help you navigate the pathways of this new terrain. Together, we can unlock the exciting potential it has to offer. In doing so, we will create an even better future for the MENAT region.

“[MENA] strategies need to...center on the development of a competitive private sector, which can provide economic opportunities that correspond to peoples’ aspirations.”

Opportunities and Challenges in the MENA Region
By Anthony O’Sullivan, Marie-Estelle Rey and Jorge Galvez Mendez
Organization for Economic Co-operation and Development

Corporate information

Saudi Arabia

Domestic Headquarters
Abdul Latif Jameel Company Ltd
PO Box 3327
Jeddah 21471
Kingdom of Saudi Arabia

info@alj.ae

United Arab Emirates

Affiliated International Headquarters
Abdul Latif Jameel International – DMCC
17th Floor, Jumeirah Business Center
Cluster G, Jumeirah Lakes Towers
PO Box: 643664
Dubai,
United Arab Emirates

info@alj.ae

Japan

Affiliated Office
Abdul Latif Jameel General
Trading Co. Ltd
1F Yusen Bldg.,
2-3-2 Marunouchi Chiyoda-ku,
Tokyo
100-0005 Japan

info@alj-japan.com

Turkey

Affiliated Office
ALJ Holding A.Ş.
Vişnezade Mah. Şehit Mehmet Sok.
Maçka Residences A Blok No:9 Kat:14
Beşiktaş
Istanbul
Turkey

info@aljturkey.com

The term 'Abdul Latif Jameel' refers broadly to several distinct, separate and independent legal entities. Abdul Latif Jameel is not itself a corporate entity, association or conglomerate run by an overarching parent company but merely refers to a group of distinct and wholly separate legal entities that are collectively referred to as Abdul Latif Jameel. Abdul Latif Jameel is not a corporate group as defined in section 1161(5) of the UK Companies Act 2006.

Publication date: October 2015, version 2.0